

VENTÜER TECHNICAL DATA SHEET

The Ventüer VL-3SD louvre system is a high performing three-stage weather louvre that provides ultimate protection from wind driven rain. The louvre blades are supported on a two-piece pressure equalised mullion system, and bordered by a 150mm frame that ejects captured water to the front of the panel. It can be combined with the VL-50CM louvre system to provide cost savings in inactive (blanked-off) areas, and can also be fitted with bird mesh, insect mesh or dust filters.

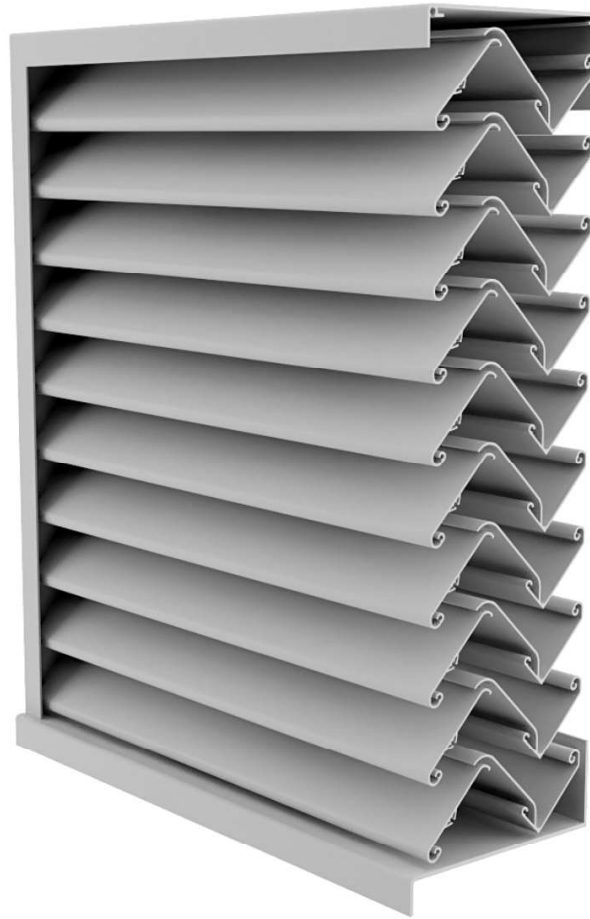

The tables below represent the VL-3SD performance results for water ingress and pressure drop when tested to BS/EN:13030. For more information and the Ventüer louvre calculator please visit www.ventuer.co.nz

Pressure Drop

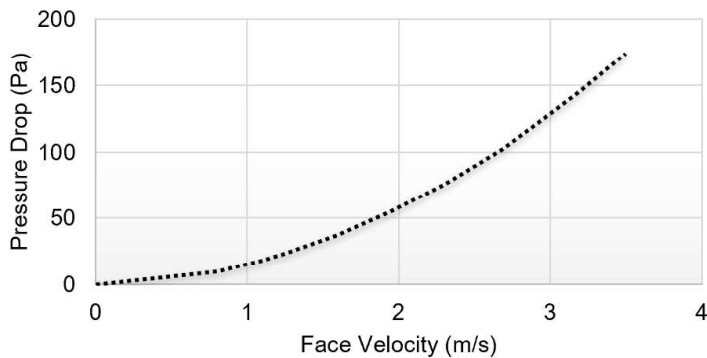

Weathering Effectiveness

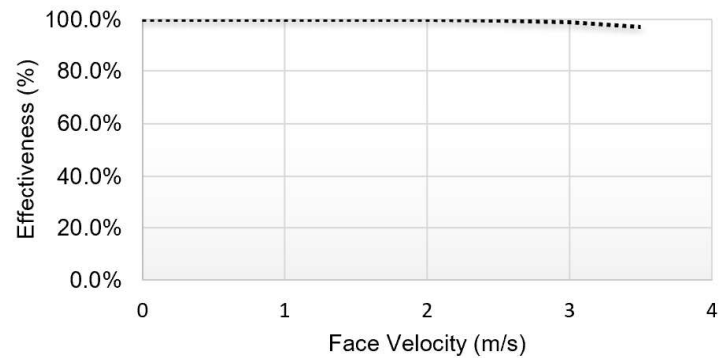

VENTILATION LOUVRE
VL-3SD



VENTÜER
High-Performance Building Ventilation

P: +64 9 973 3616
W: ventuer.co.nz
© 2019 All rights reserved

Scale: 1:4
Date: 27.03.2019

VL-3SD Ver.1

VENTÜER TECHNICAL DATA SHEET

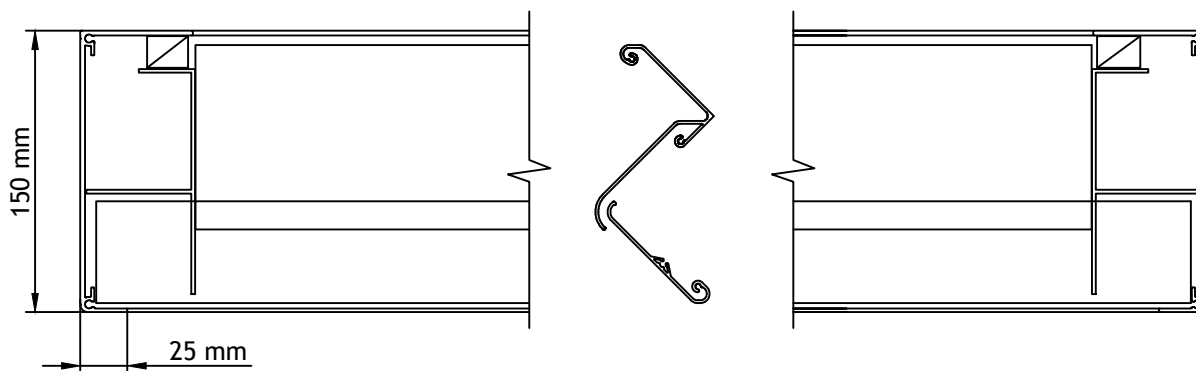

FLANGED FRAME - HORIZONTAL SECTION

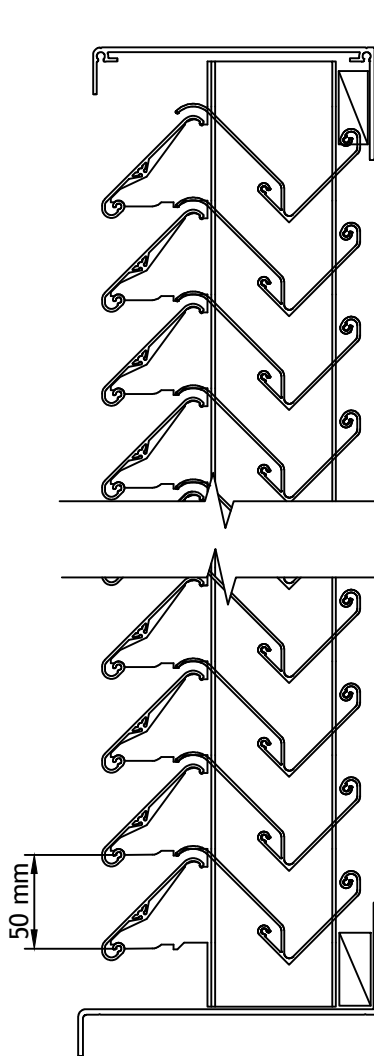

FLANGED FRAME
VERTICAL SECTION



VL-3SD HEAD/JAMB FRAME



VL-3SD LOUVRE BLADE -
FRONT HALF

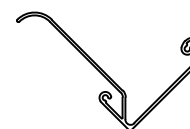

VL-3SD LOUVRE BLADE -
REAR HALF

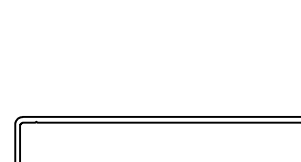

VL-3SD SILL FRAME

VENTILATION LOUVRE
VL-3SD



VENTÜER
High-Performance Building Ventilation

P: +64 9 973 3616
W: ventuer.co.nz
© 2019 All rights reserved

Scale: 1:4
Date: 27.03.2019

VL-3SD Ver.1