

VENTÜER TECHNICAL DATA SHEET

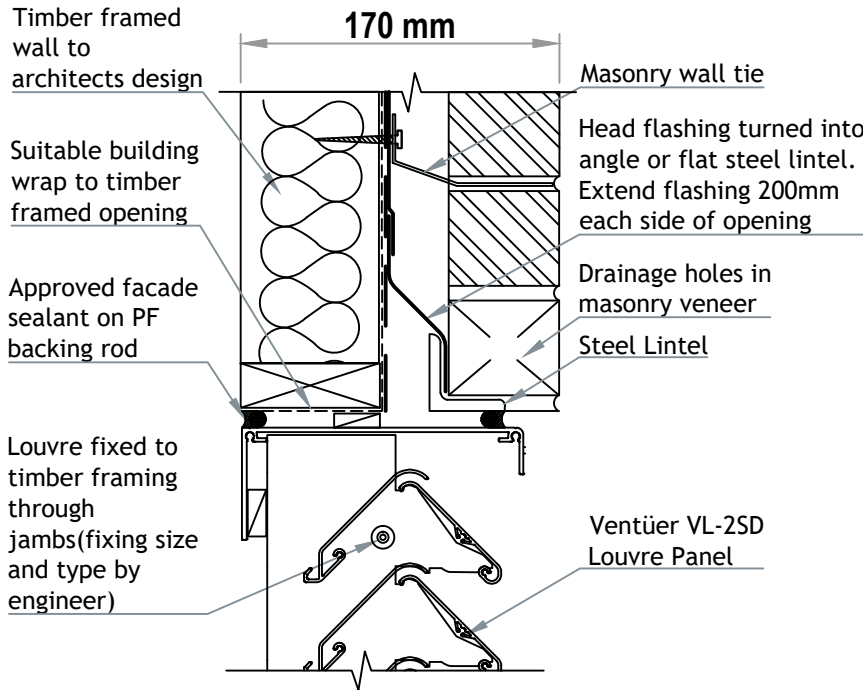

**VL-2SD (FLANGED FRAME)
HEAD DETAIL 01
SCALE 1 : 4**

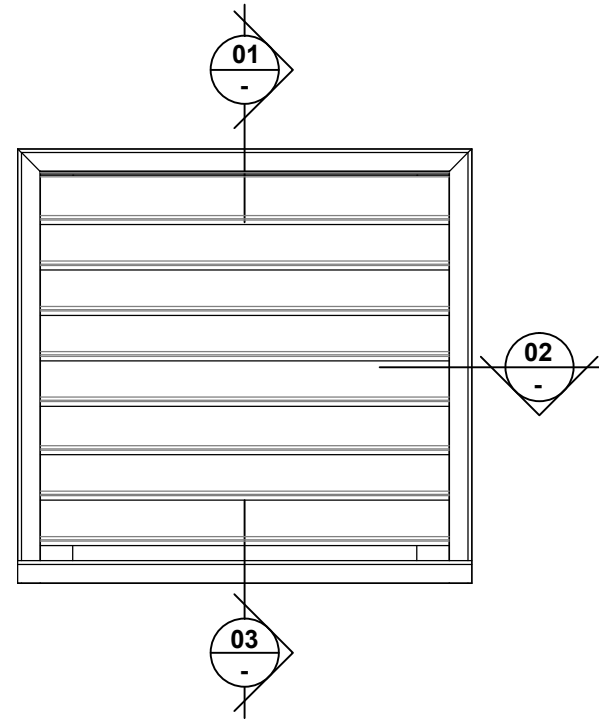

VL-2SD LOUVRE (FLANGED FRAME)

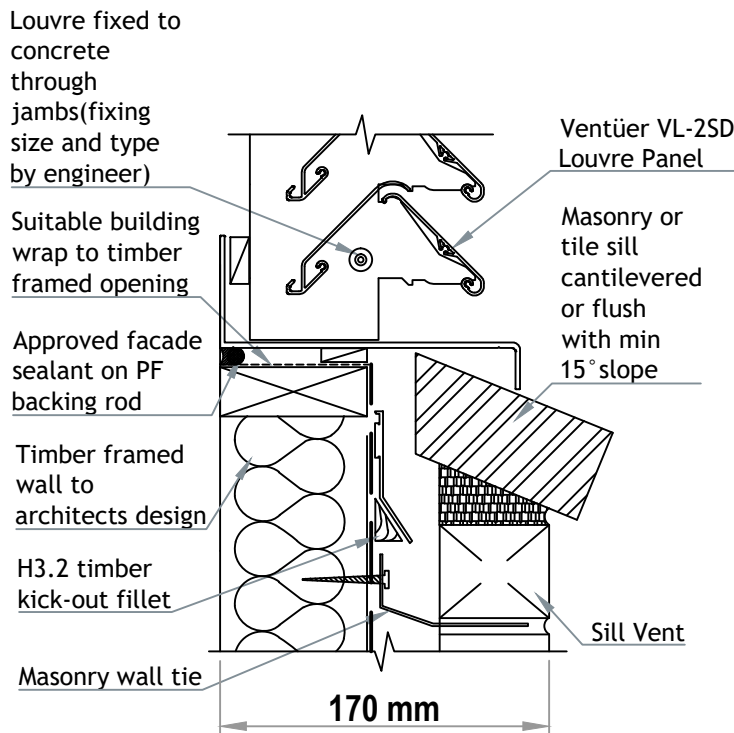

**VL-2SD (FLANGED FRAME)
SILL DETAIL 03
SCALE 1 : 4**

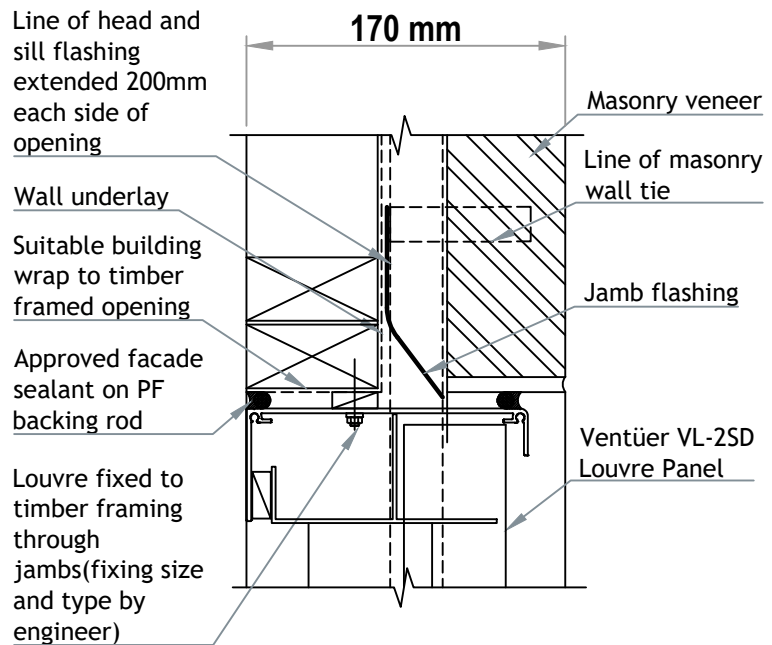

**VL-2SD (FLANGED FRAME)
JAMB DETAIL 02
SCALE 1 : 4**

VENTILATION LOUVRE
VL-2SD
FIXING TO BRICK



VENTÜER
High-Performance Building Ventilation

P: +64 9 973 3616
W: ventuer.co.nz
© 2019 All rights reserved

Scale: 1 : 4
Date: 29/03/2019

VL-2SD Ver.1